

Fitting instructions

Make: Toyota

RAV4; 12/2012->

Type: 5703

МАГАЗИН



ФАРКОПОВ

+7 (495) 6-693-693

www.magfarkop.ru

magfarkop@yandex.ru

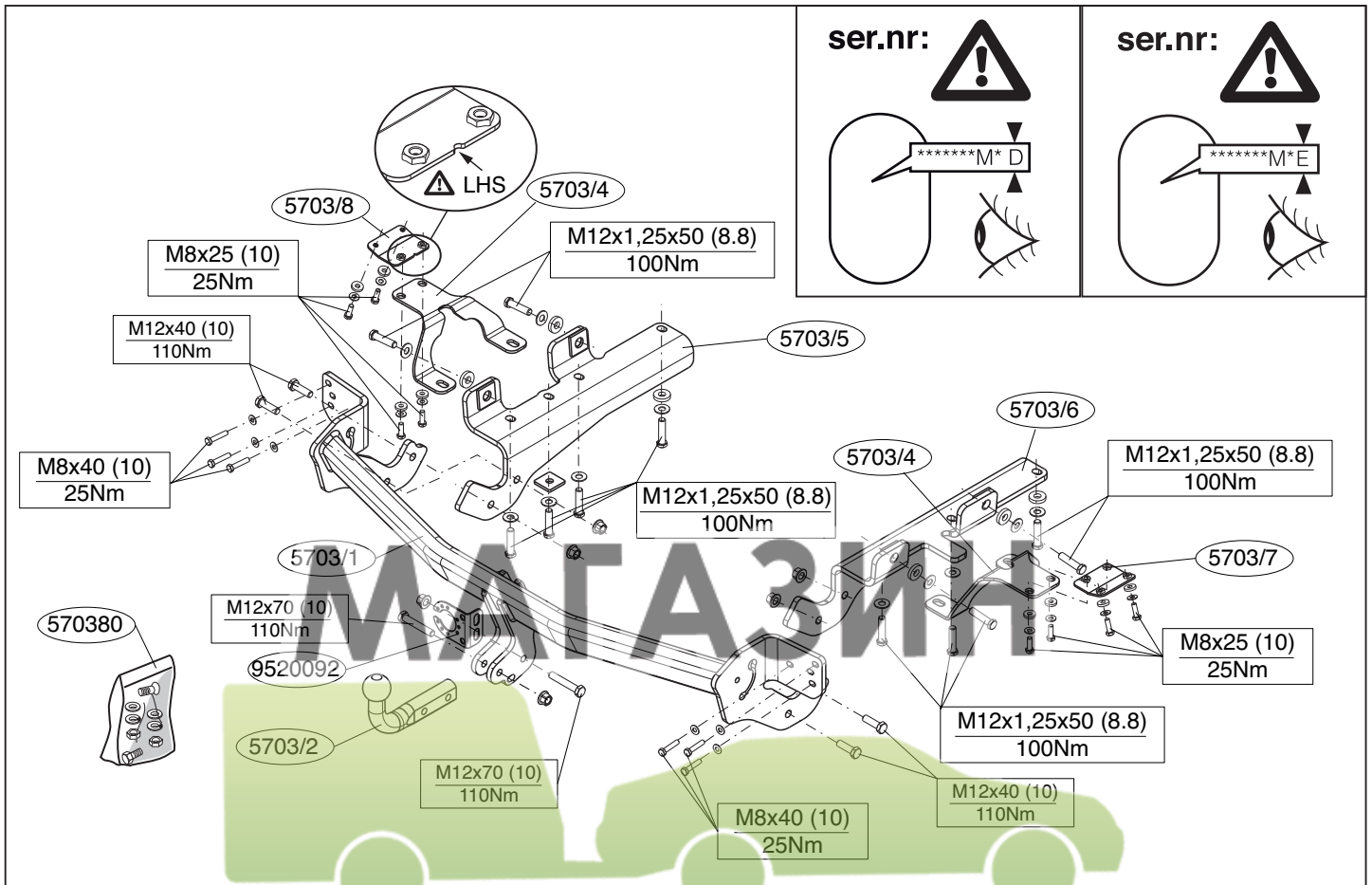

© 570370/27-05-2013/1

МАГАЗИН ФАРКОПОВ

Dispositivo di traino tipo: 5703
 Per autoveicoli: TOYOTA RAV4; 12 / 2012->
 Tipo funzionale: ** A4 ** - AN *** W

+7 (495) 6-693-693

Classe e tipo di attacco: A50-X
 Omologazione: E11 55R 018607
 Valore D: 10,9 kN
 Carico Verticale max. S: 80 kg
 Larghezza rimorchiabile per Caravan e T.A.T.S.: 2,45m vedere CARTA di CIRCOLAZIONE VEICOLO (motrice) + 70 cm = ..arrotondare ai 5 cm superiore (vedi D.M.28/05/85)
 Massa rimorchiabile: vedi carta di circolazione dell' autoveicolo

w.w.magfarkop.ru
magfarkop@yandex.ru

Per verificare l'idoneità del dispositivo di traino omologato a norma ECE/R55, all'installazione sulla vettura su cui si intende procedere al montaggio, compilare la seguente formula (se necessario declassare la massa rimorchiabile):

$$D = \frac{T \times C}{T + C} \times 0,00981 \leq 10,9 \text{ kN}$$

dove: T= Massa Complessiva Max. della motrice (in kg)
 C= Massa Rimorchiabile Max. della motrice (in kg)

DA COMPILARE PER IL COLLAUDO

DICHIARAZIONE DI CORRETTO MONTAGGIO: la sottoscritta Ditta dichiara di aver montato in maniera corretta ed in conformi/ alle prescrizioni sia del costruttore del veicolo che del costruttore del dispositivo stesso il seguente dispositivo di attacco meccanico:

tipo:.....
 Il dispositivo di attacco sopra indicato è stato installato su autoveicolo
 modello:.....
 targa:.....
 Data:.....

TIMBRO e FIRMA

Si dichiara inoltre di aver informato l'utente del veicolo sull'USO e MANUTENZIONE del dispositivo stesso.

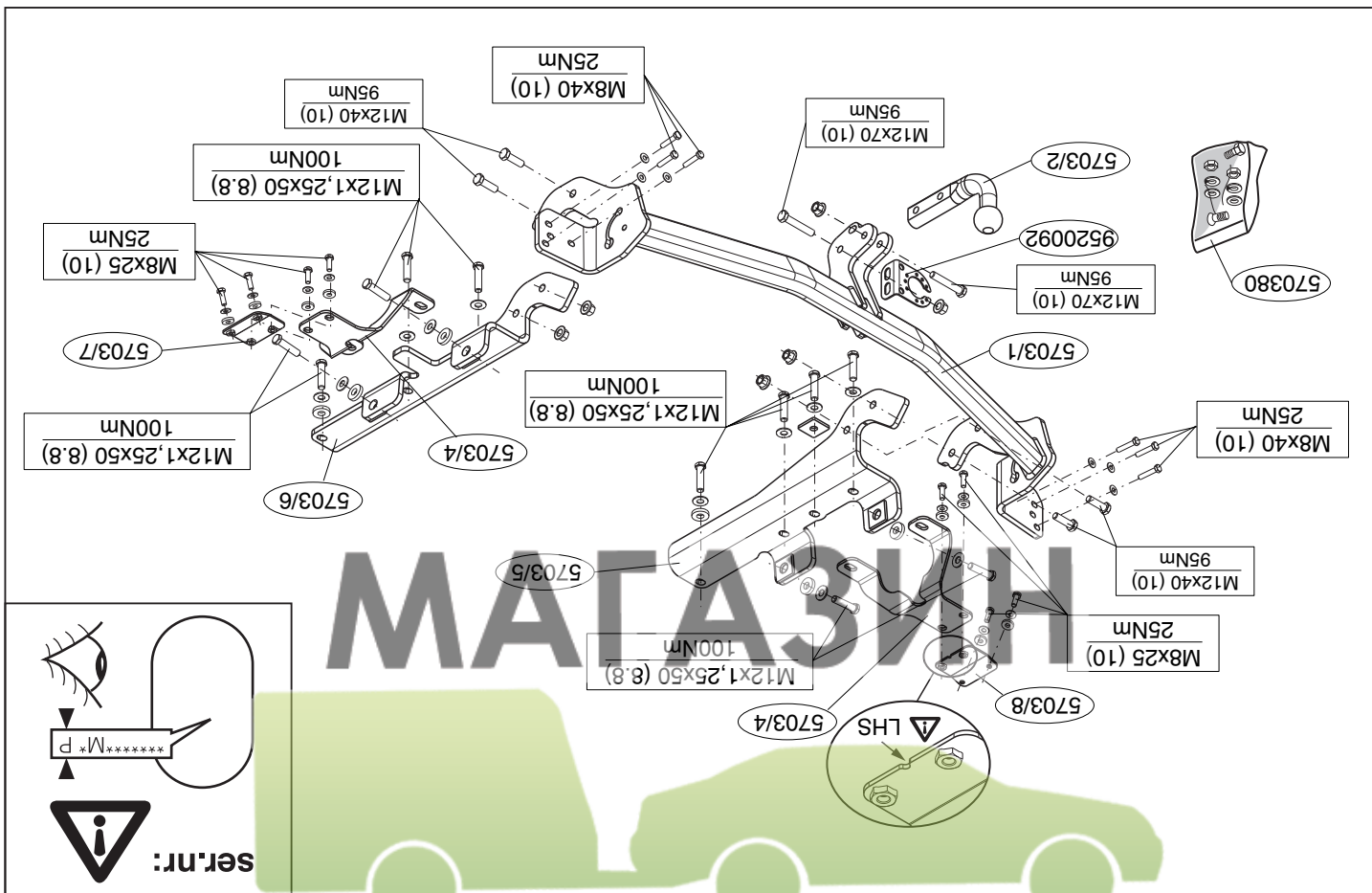

МАГАЗИН

ФАРКОП

+7 (495) 6-693-693

www.magfarkop.ru
magfarkop@yandex.ru

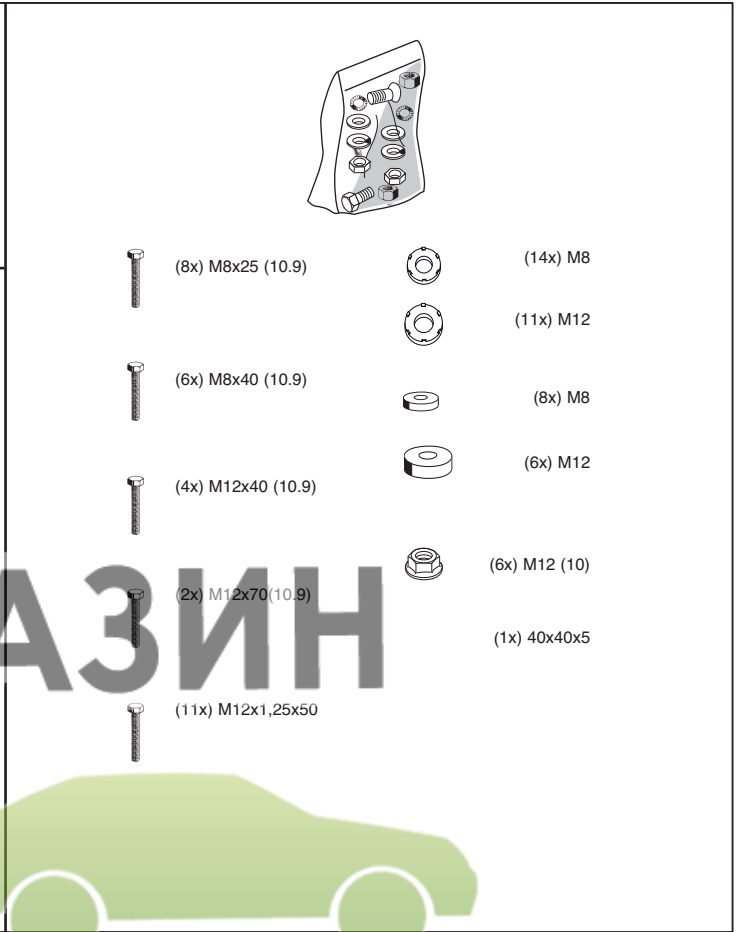
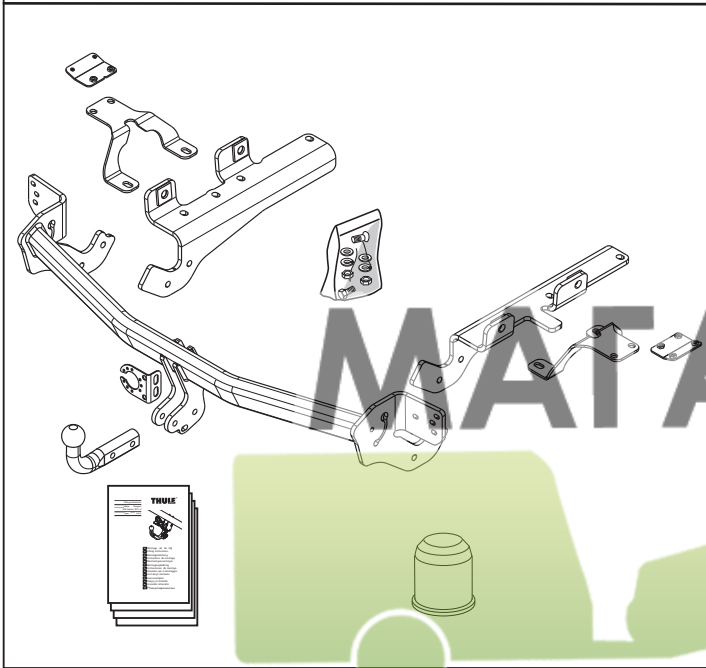
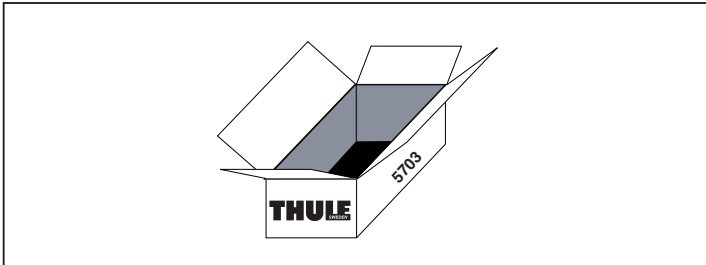

© 570370/27-05-2013/3

МАГАЗИН ФАРКОПОВ

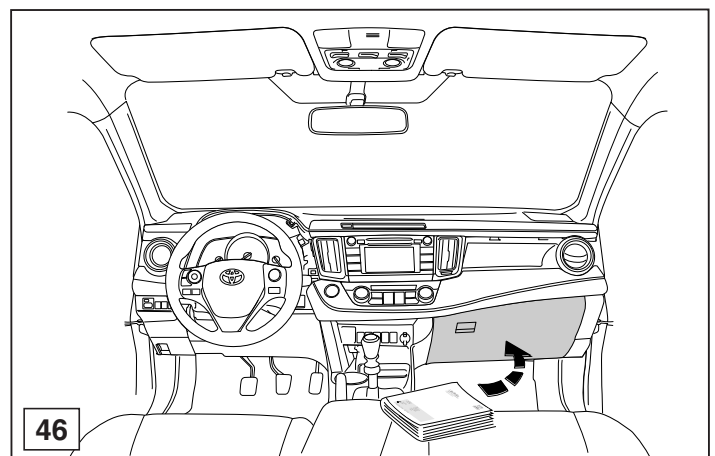
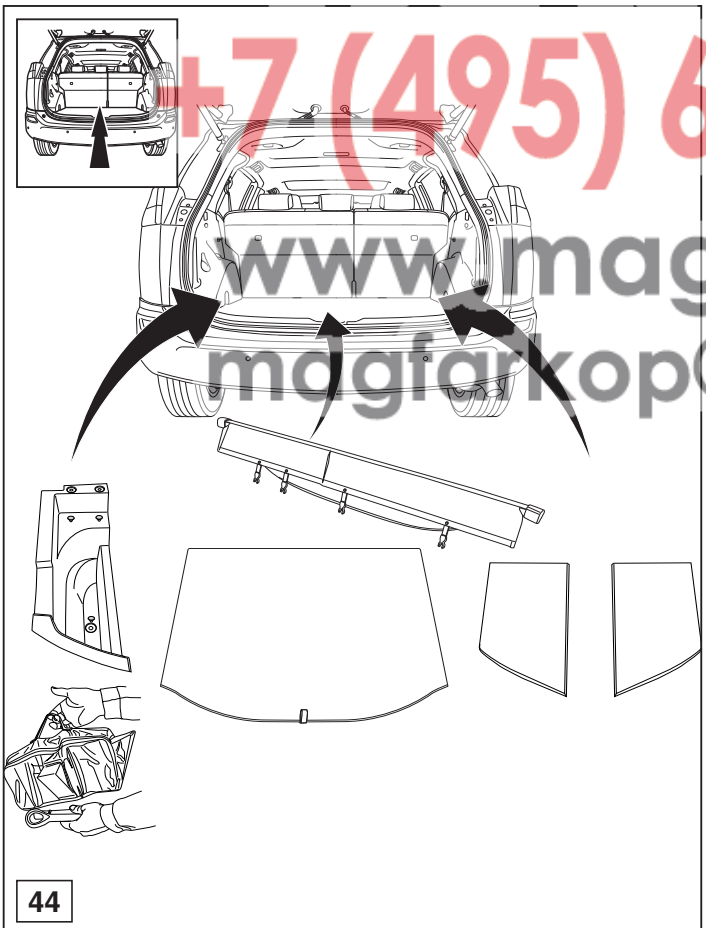

+7 (495) 6-693-693
www.magfarkop.ru
magfarkop@yandex.ru

© 570370/27-05-2013/28

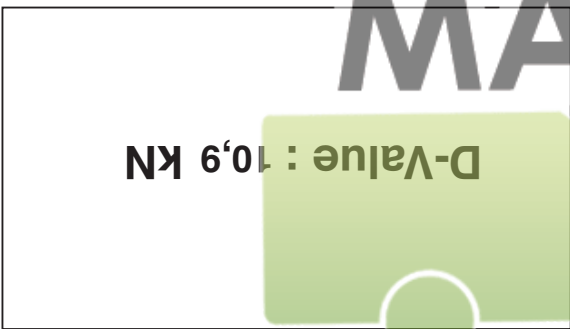
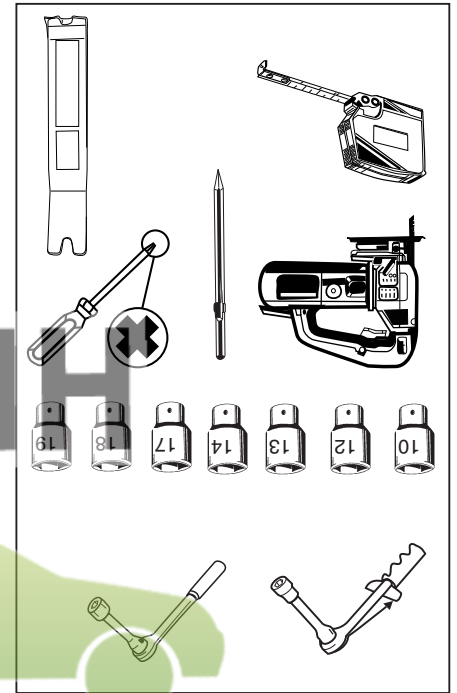
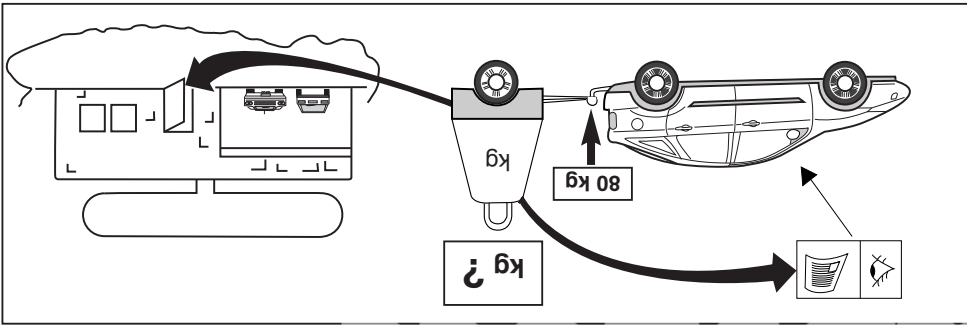
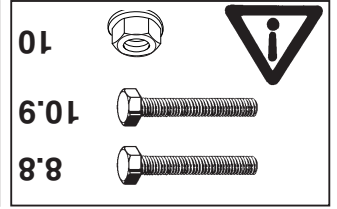
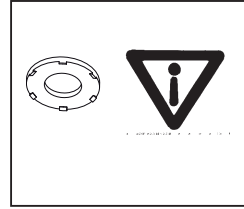
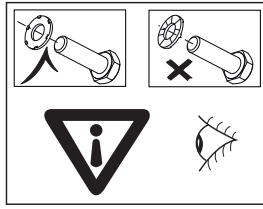
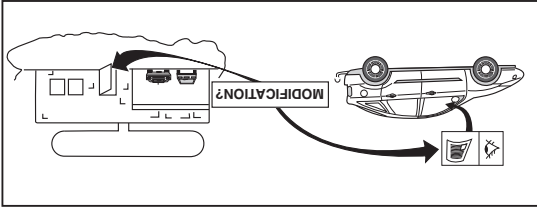

МАГАЗИН ФАРКОПОВ

+7 (495) 9-93-693

www.magfarkop.ru
magfarkop@yandex.ru

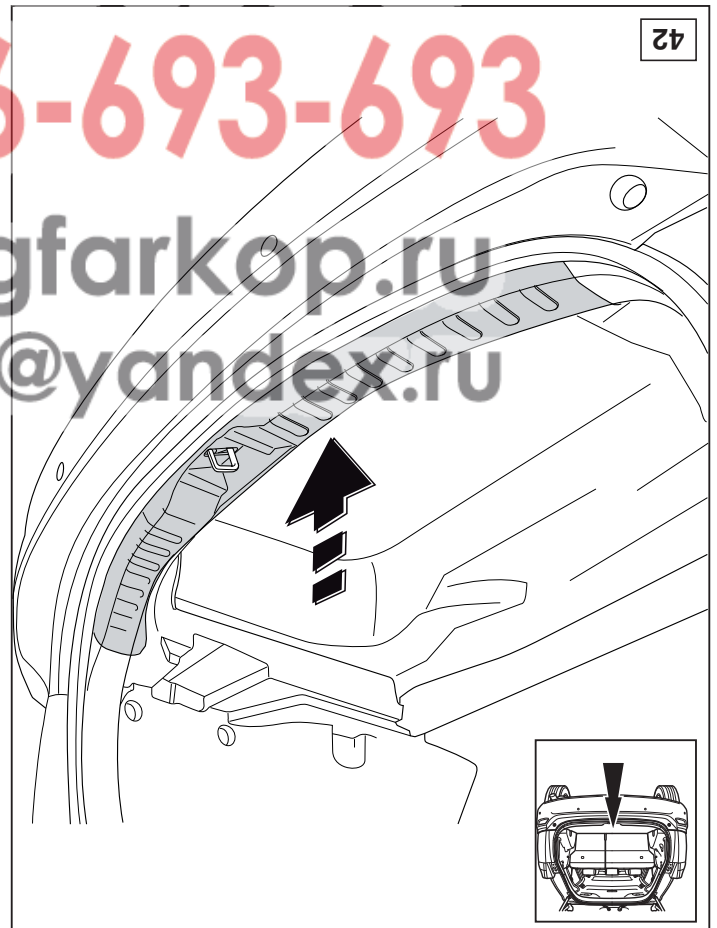
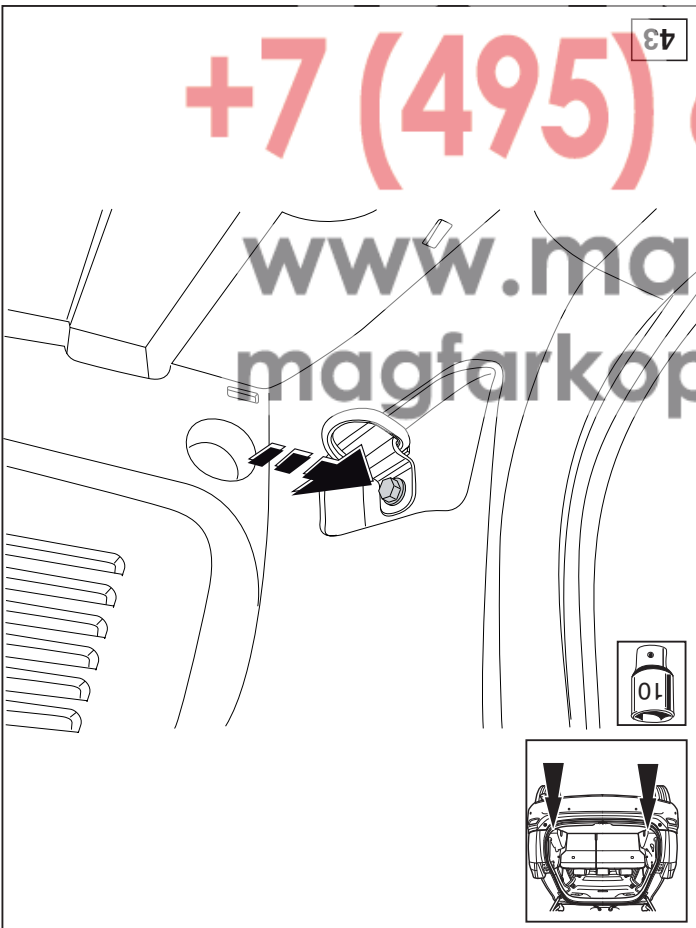



NL.

* Thule is niet aansprakelijk voor de schade die het direct of indirect gevolg is van onjuiste montage, daaronder begrepen gebruik van niet-geschikte gereedschappen en het gebruik van andere dan de voorgeschreven montagewijze en middelen, dan wel onjuiste interpretatie van dit onderhavig montagevoorschrift.

GB.

NOTE:

* **Should this installation process entail the cutting of the bumper – conformation MUST be obtained by the installation engineer of the customer’s acceptance prior to completion. Thule Towing Systems do not accept responsibility for any matters arising as a result of this miscommunication.**

All measurements are in mm!

* Thule is not liable for damage caused directly or indirectly by incorrect assembly, including the use of unsuitable tools, the use of other assembly methods and means than the ones outlined, and the incorrect interpretation of these assembly instructions.

D.

HINWEISE:

* Die für das Fahrzeug zugelassene Anhängelast ist den Fahrzeug Unterlagen zu entnehmen. Bei Änderungen des Fahrzeuggewichtes muß die höchstzulässige Anhängelast gegebenenfalls aus dem D-Wert nachgerechnet werden.

Auskunft hierüber kann Ihr Fachhändler oder der TÜV geben.

* Elektrische Anlage gemäß StVZO anbringen.

* Thule haftet nicht für Schäden, die als direkte oder indirekte Folge einer nicht ordnungsgemäßen Montage auftreten, darunter fallen auch die Benutzung von ungeeigneten Werkzeugen, andere als die vorgeschriebenen Montageverfahren und Montagemittel sowie eine fehlerhafte Interpretation der betreffenden Montageanweisung.

F.

* Thule décline toute responsabilité pour les dommages qui pourraient directement ou indirectement résulter d’un montage incorrect, y compris l’utilisation d’outils inappropriés et l’utilisation d’un mode d’emploi et de moyens autres que ceux prescrits, ou bien résulter d’une interprétation inexacte des présentes instructions de montage.

S.

* Thule är inte ansvariga för skada som orsakats direkt eller indirekt av felaktig montering, inklusive användning av olämpliga verktyg, andra monteringsmetoder och processer än de som beskrivs, samt felaktig tolkning av dessa monteringsinstruktioner.

DK.

* Thule er ikke ansvarlig for skade der direkte eller indirekte er forårsaget af forkert montage, herunder også iberegnet brug af forkert værktøj og anvendelse af anden montage metode og andre montage midler end de foreskrevne samt fejltolkning af den medfølgende montagevejledning.

E.

* Thule no se responsabiliza por daños causados, directa o indirectamente, por un montaje incorrecto, incluyendo el uso de herramientas inadecuadas, por el uso de métodos de montaje y medios distintos a los indicados y por la interpretación incorrecta de estas instrucciones de montaje.

I.

* Thule non può essere ritenuta responsabile per eventuali danni direttamente o indirettamente dovuti ad un errato montaggio, intendendo con ciò anche l’uso di attrezzi non idonei e l’uso di metodi e mezzi di montaggio diversi da quelli prescritti, nonché all’errata interpretazione delle seguenti istruzioni di montaggio.

PL.

* Firma Thule nie ponosi odpowiedzialności za straty poniesione pośrednio lub bezpośrednio na skutek niewłaściwego montażu, w tym użycia

© 570370/27-05-2013/5

МАГАСИЛ
ФАРКОПОВ



© 570370/27-05-2013/26

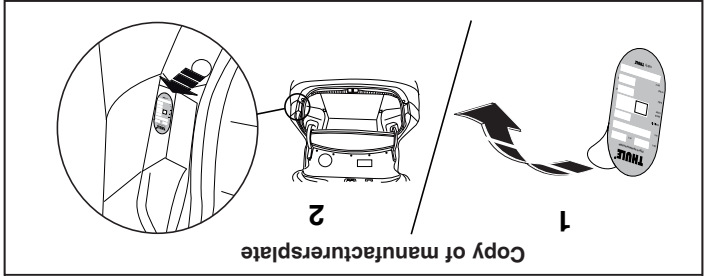
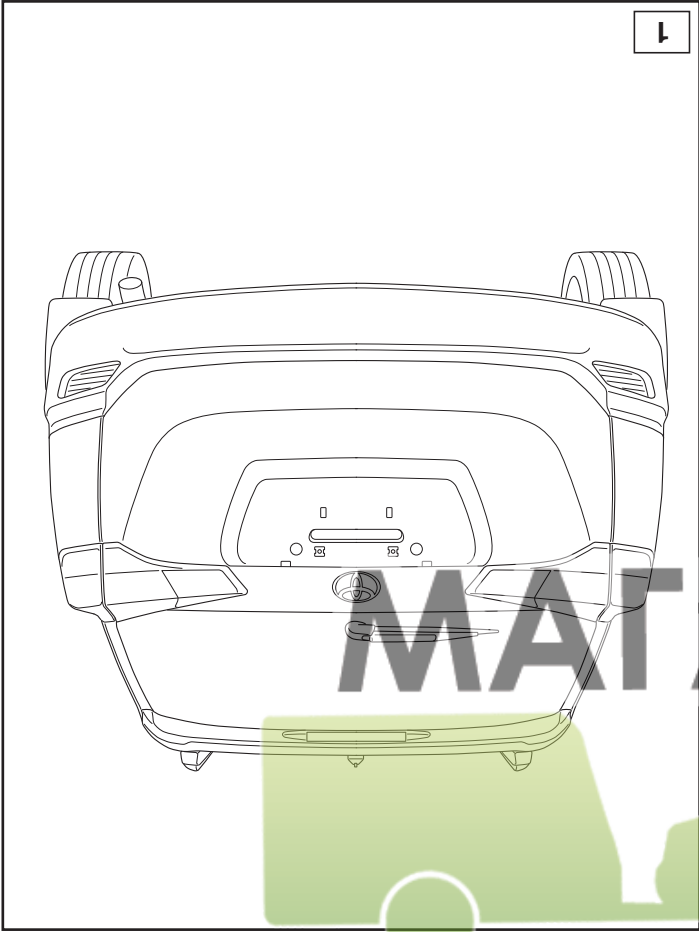

niewzasciwych narzędzi i sposobów montażu niezgodnych z instrukcją, oraz niezastosowanie się do treści instrukcji.

SF: * Thule ei ole vastuussa violitumisesta, jōka on suoraan tai epäsuoraan aiheutunut vāärāstä asennuksesta samoin kuin sopimattomien työkālu- jen kāytōstā, muiden kuin ohjeissa mainittujen asennusmenetelmien tai vāllinneiden kāytōstā sekā kyseisten asennusohjeiden vāärinlūklinnasta.

CZ: * Společnost Thule neodpovídā za prīmē ani neprīmē škody zpūsobenē nespřāvnuu montāži, včetnē použitī nevhodnūch nāstrojū, použitī jinūch metod montāže a prostředkū nez vvedenūch a nespřāvnuūm pocho- penīm tēchto pokynū k montāži.

H: * A Thule nem vállal felelőséget a nem megfelelő szerelésből kővetlen vagy kővetett módon kővetkezō kārōkért. Ez vonatkozīk a nem megf- eldō szerzsāmok hasznālatāra, a leírattól eltérō módszerek ēs eszkōzōk alkalmazāsāra, valamint a szerelési útmutatō tēves értel- mezésére.

RUS: * Фирма Thule не отвечает за ущерб, являющийся прямым или косвенным след- ствием неправильного монтажа, в том числе использования неподходящих инструментов и применения иного способа монтажа или других средств, чем предписано в инструкции, либо неправильного истолкования настоящей инструк- ции по монтажу.

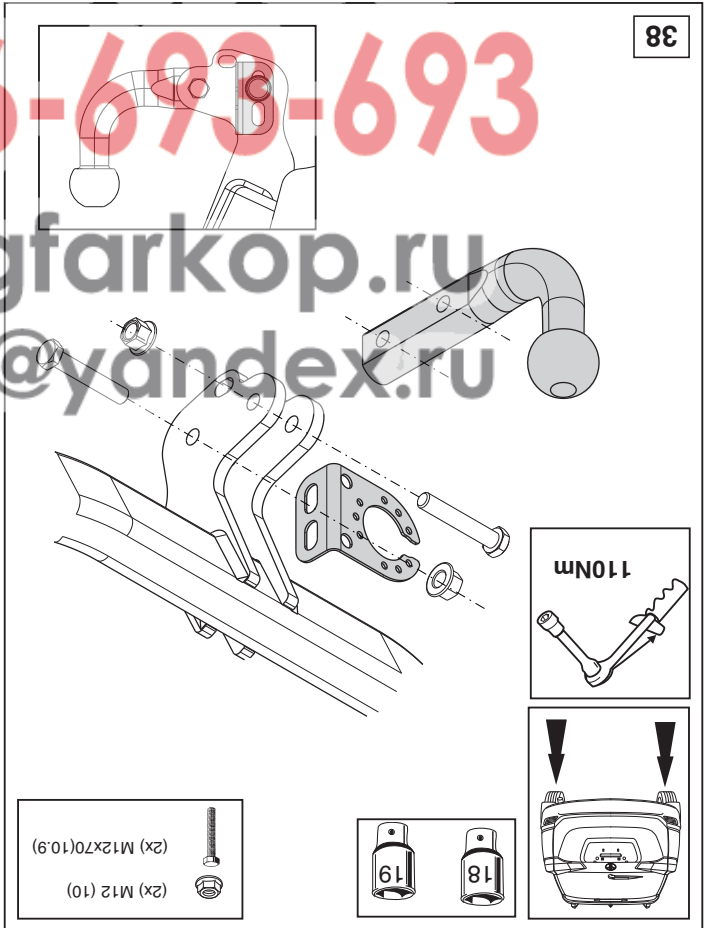
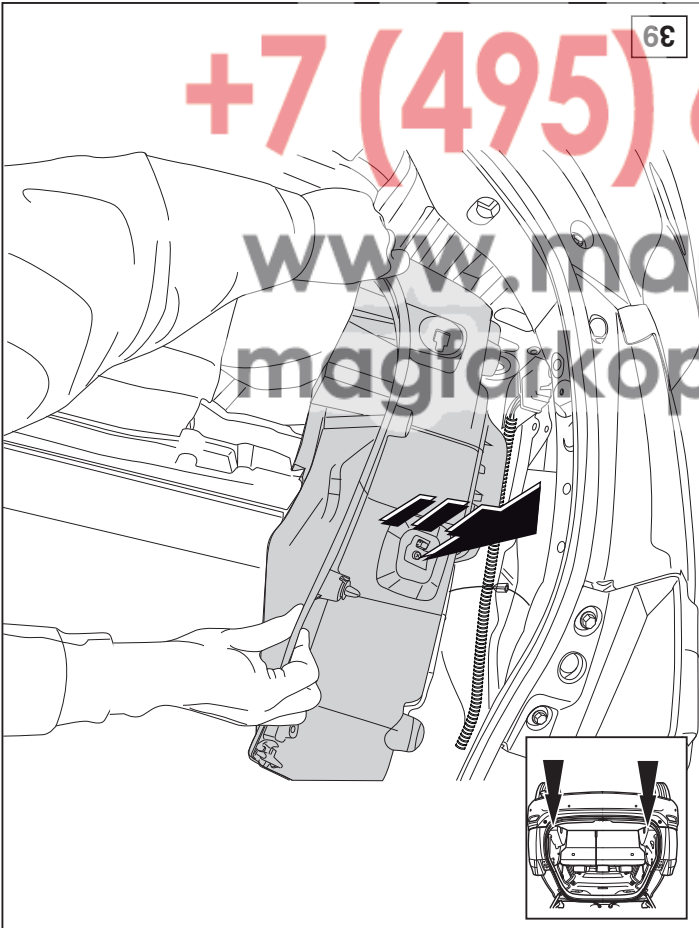

ФАРКОПОВ

+7 (495) 9-693-693

www.magfarkop.ru
magfarkop@yandex.ru

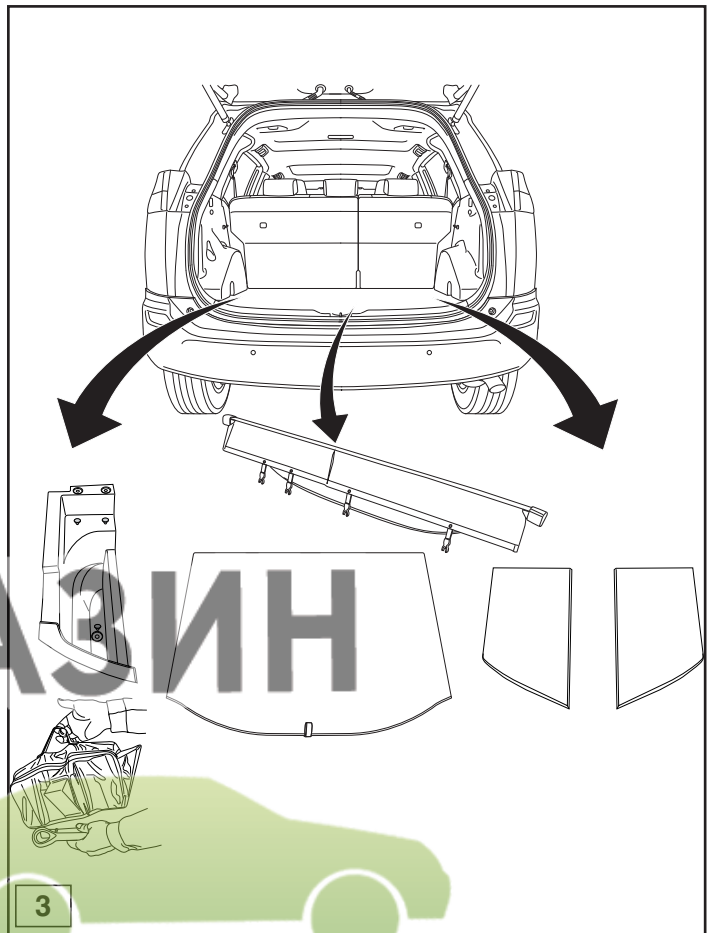
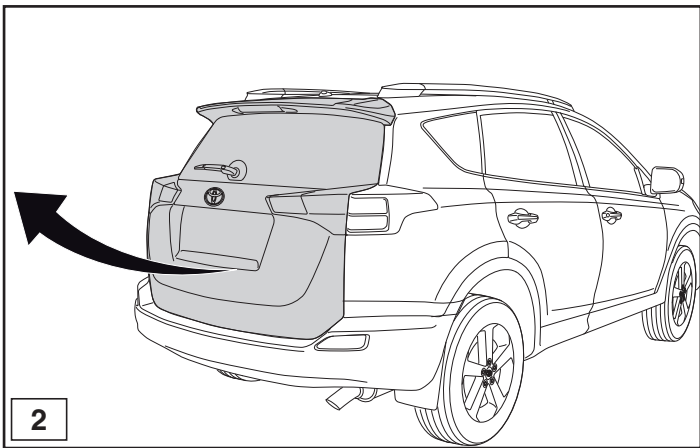

© 570370/27-05-2013/7

МАГАЗИН ФАРКОПОВ

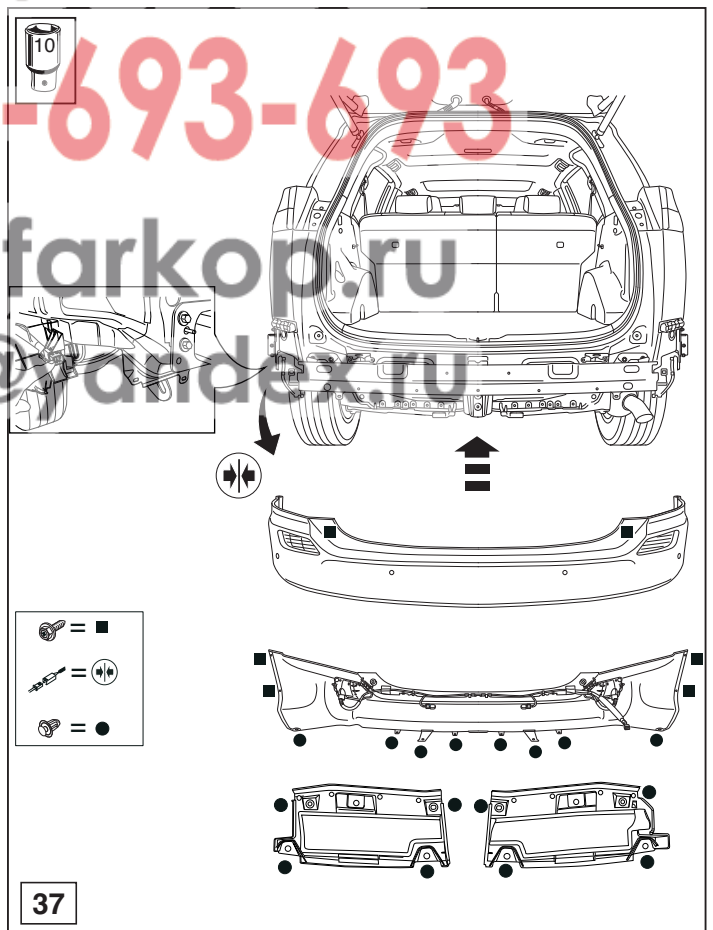
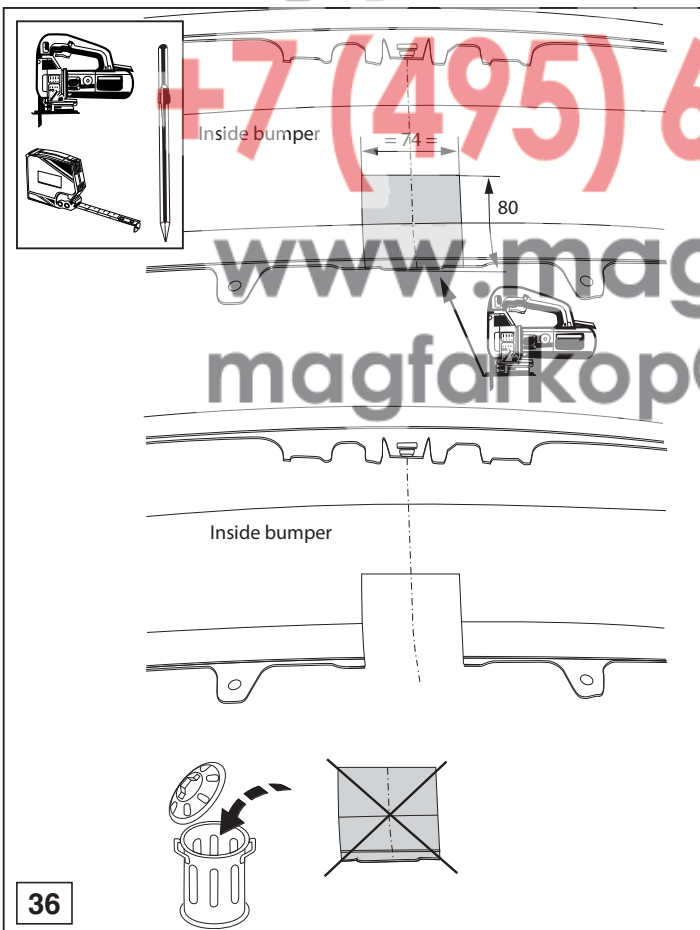

© 570370/27-05-2013/24

+7 (495) 6-693-693
www.magfarkop.ru
magfarkop@yandex.ru

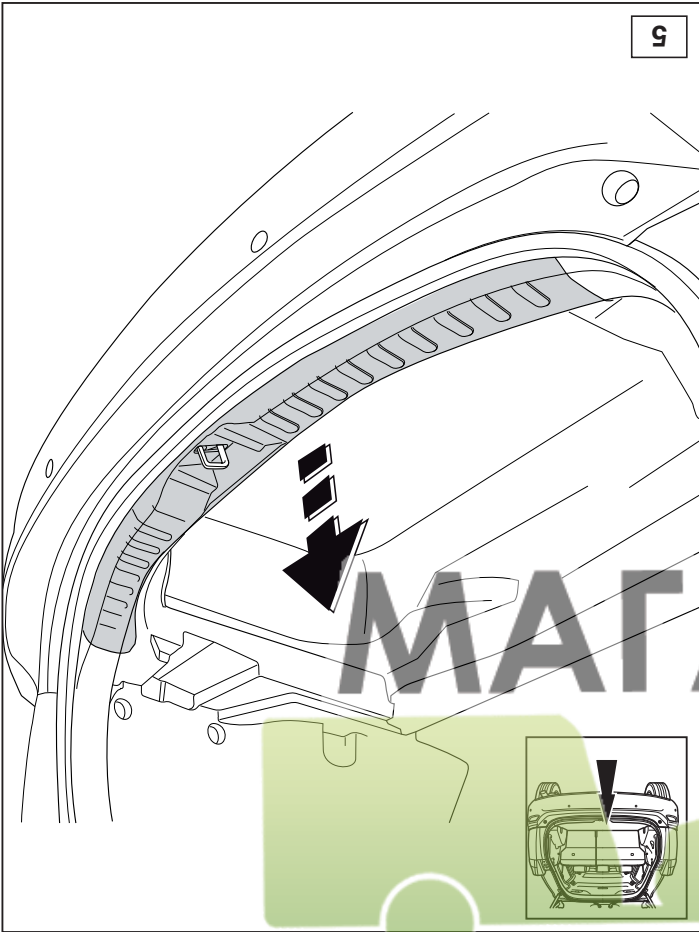

ФАРКОПОВ

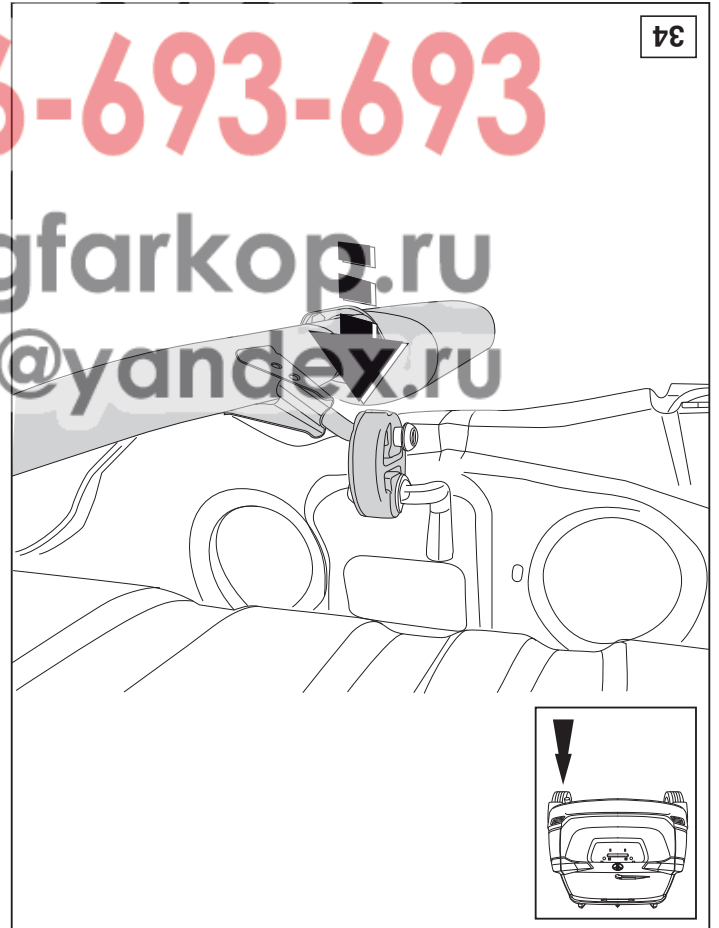
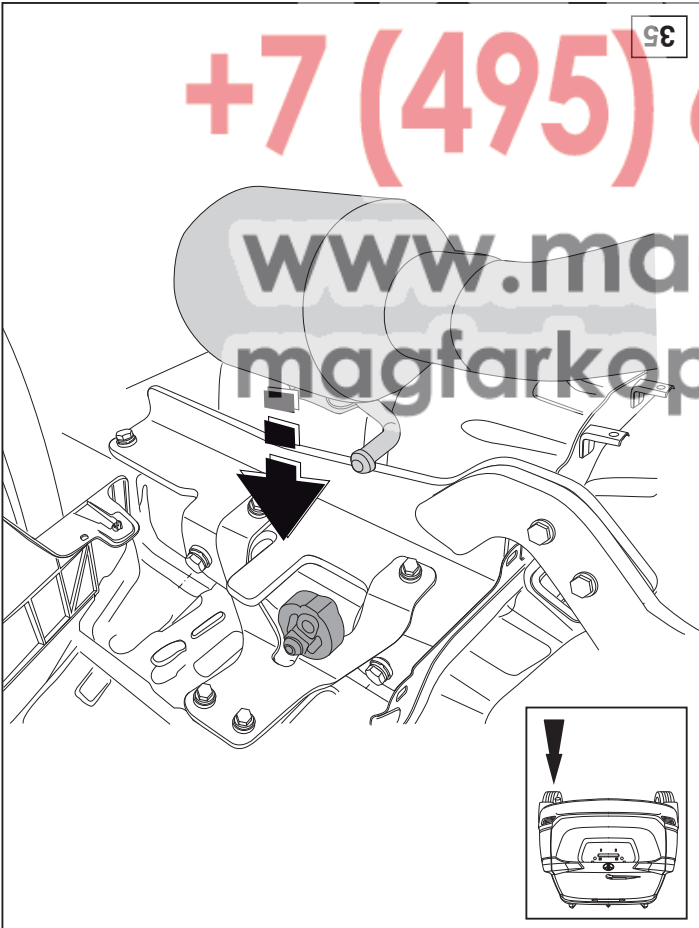

+7 (495) 6-93-693

www.magfarkop.ru
magfarkop@yandex.ru

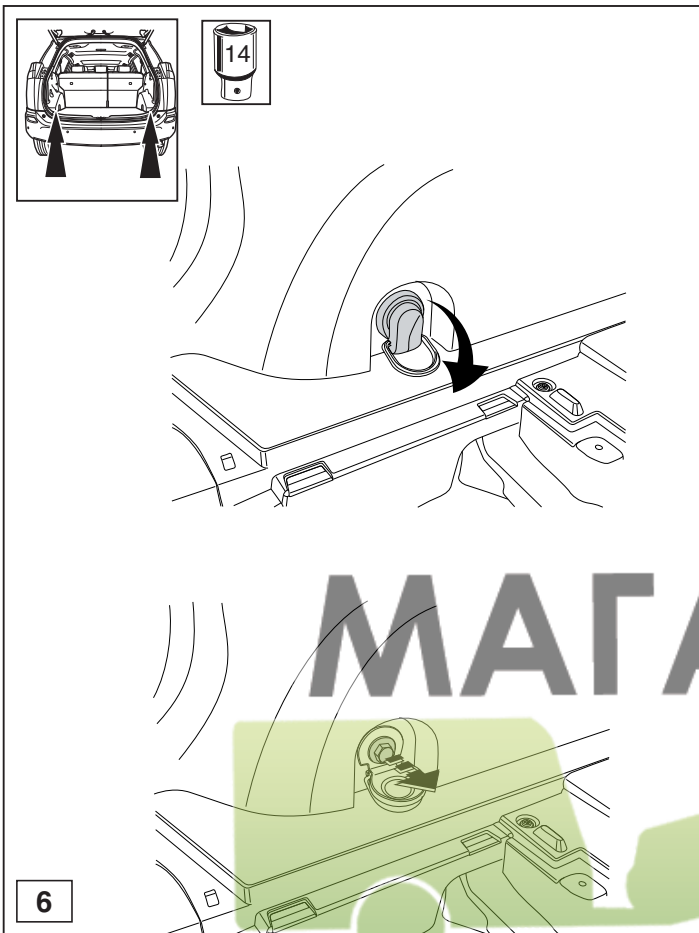

© 570370/27-05-2013/9

МАГАЗИН ФАРКОПОВ

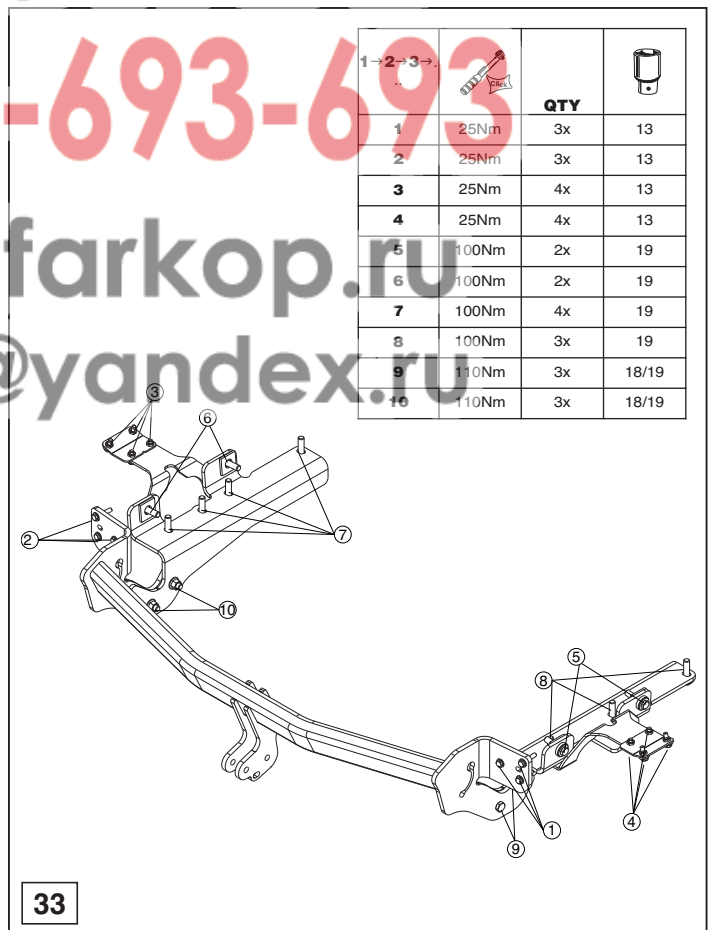

© 570370/27-05-2013/22

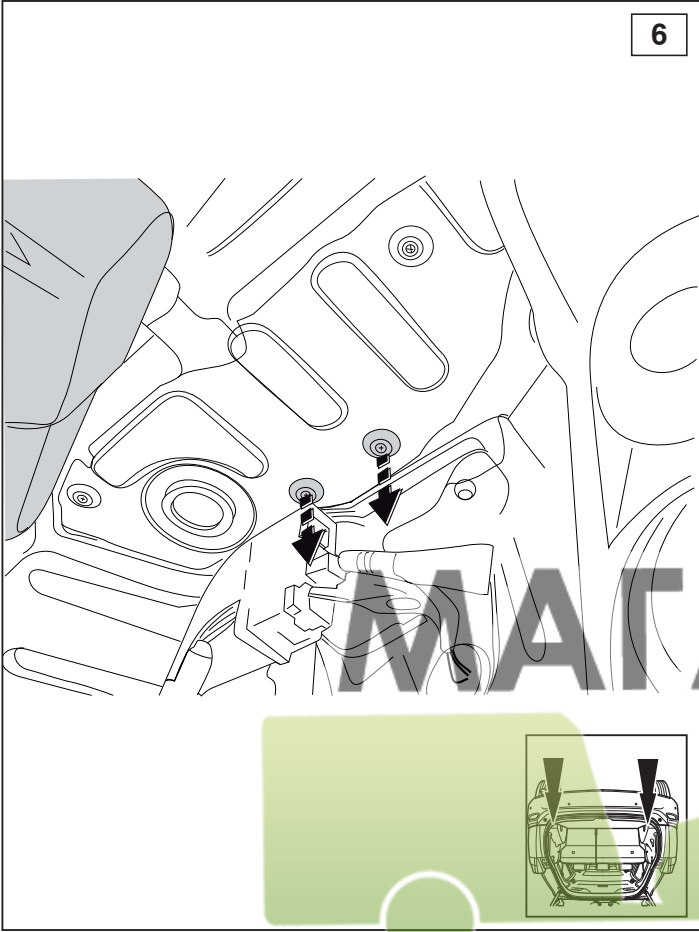

ФАРКОПОВ

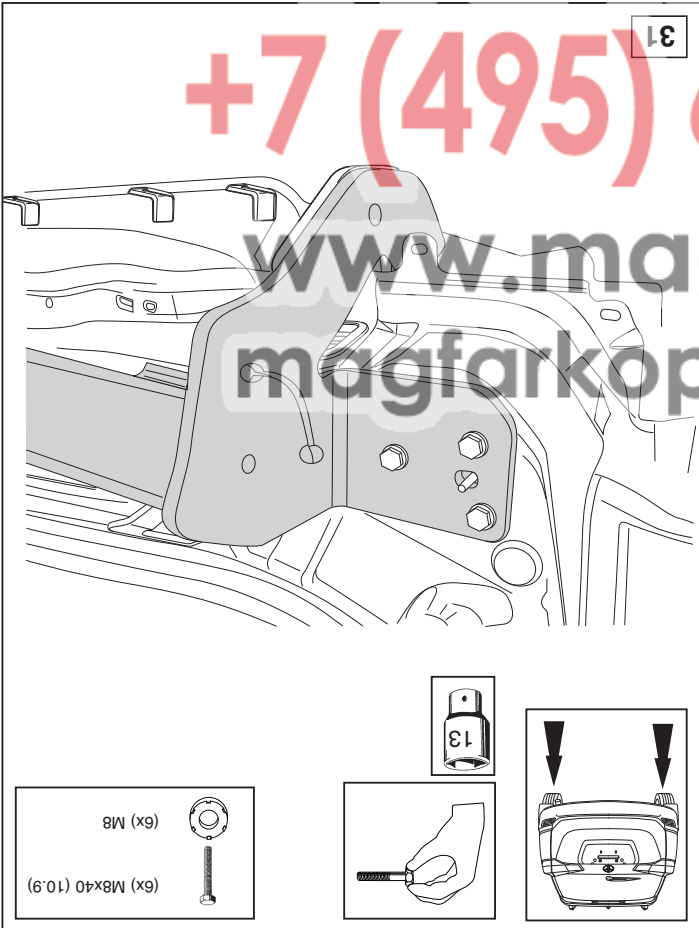

+7 (495) 6-693-693

www.magfarkop.ru

magfarkop@yandex.ru

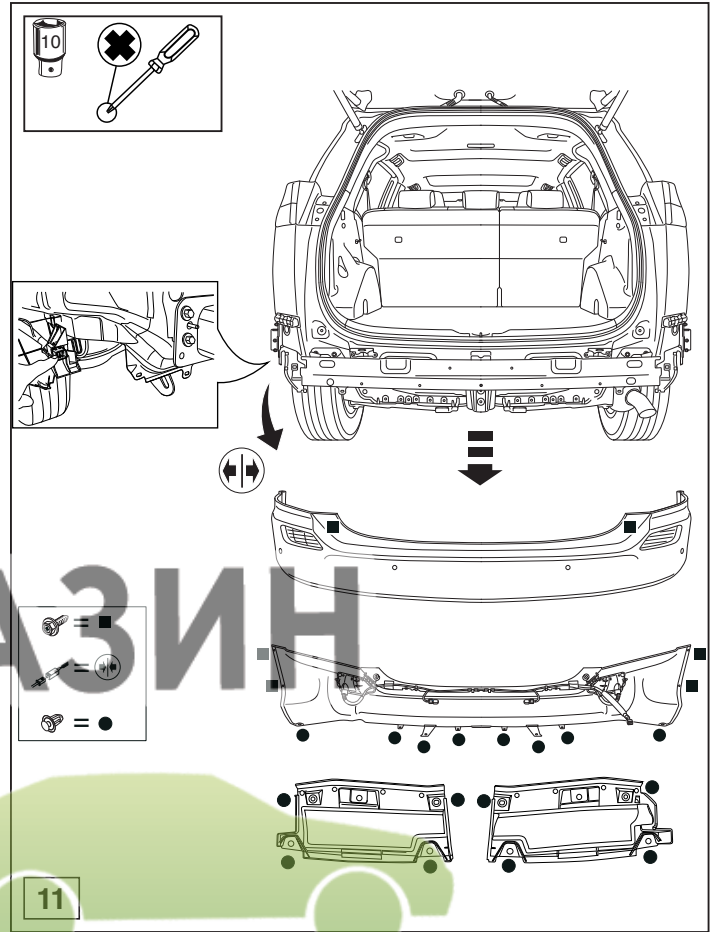
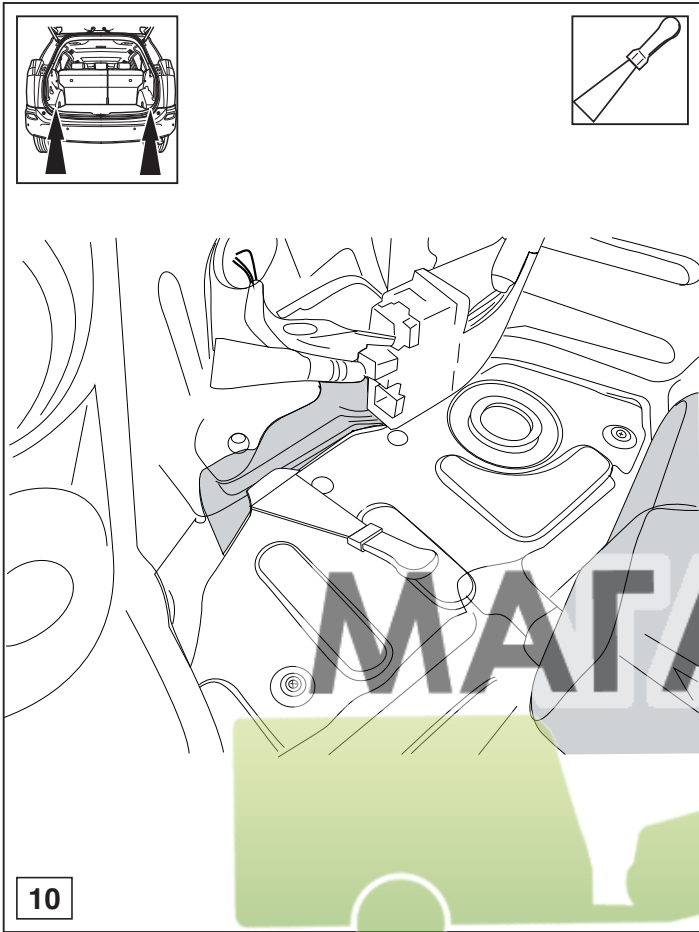

© 570370/27-05-2013/11

МАГАЗИН ФАРКОПОВ



© 570370/27-05-2013/20

+7 (495) 6-693-693

www.magfarkop.ru
magfarkop@yandex.ru

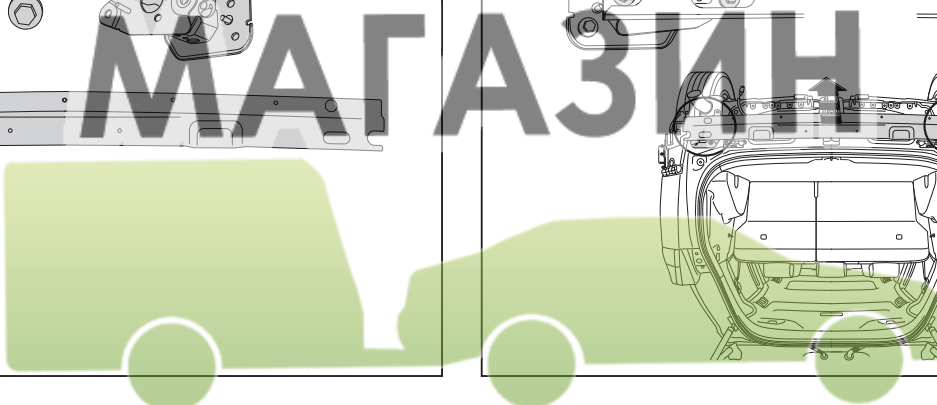
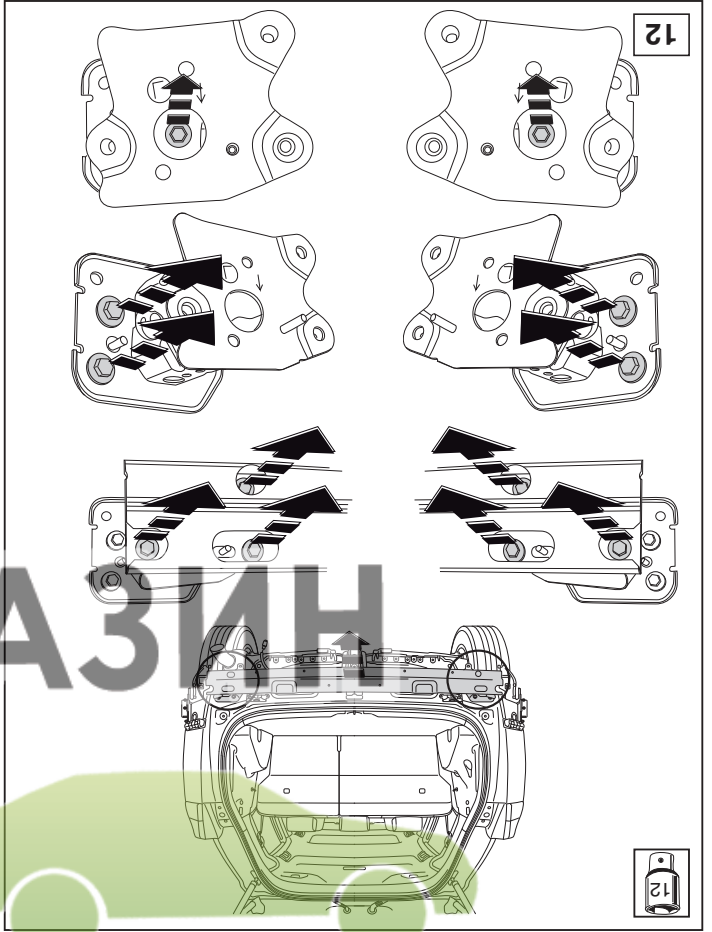
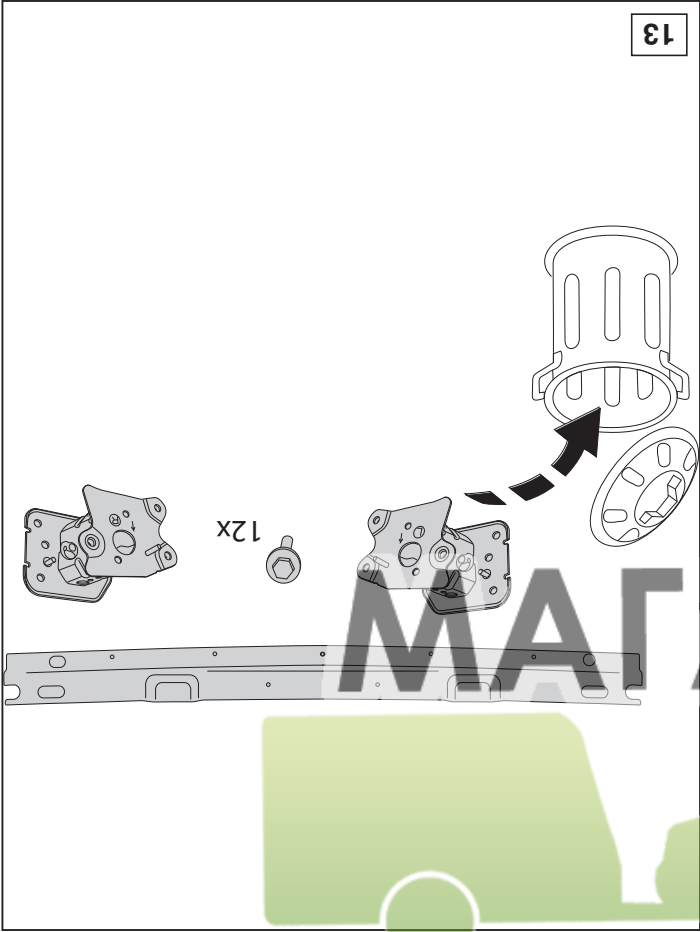

ФАРКОПОВ



+7 (495) 6-693-693

www.magfarkop.ru
magfarkop@yandex.ru

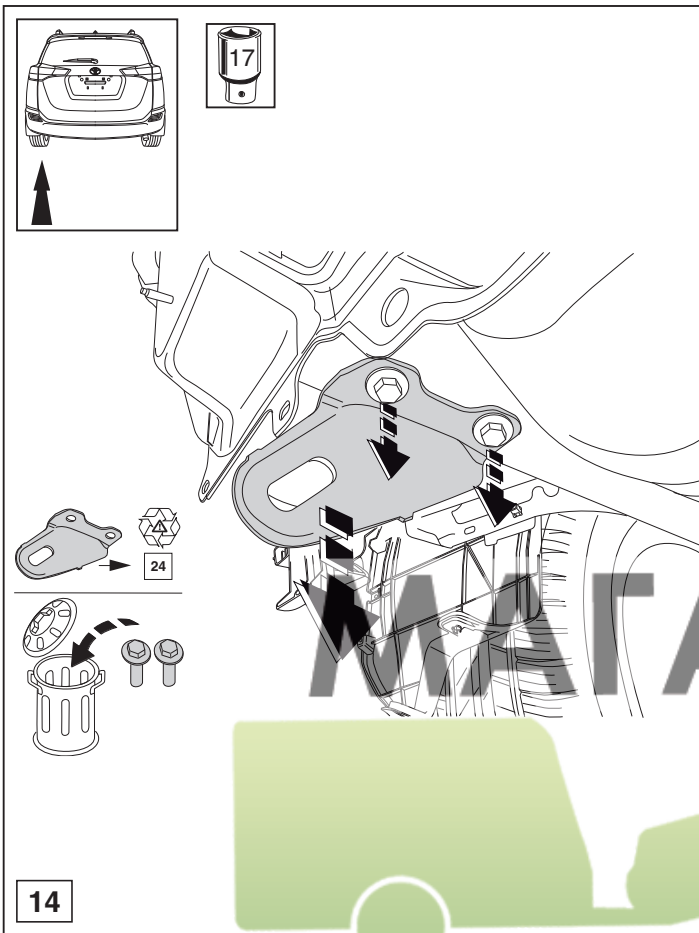

© 570370/27-05-2013/13

МАГАЗИН ФАРКОПОВ



+7 (495) 6-693-693

www.magfarkop.ru
magfarkop@yandex.ru

© 570370/27-05-2013/18

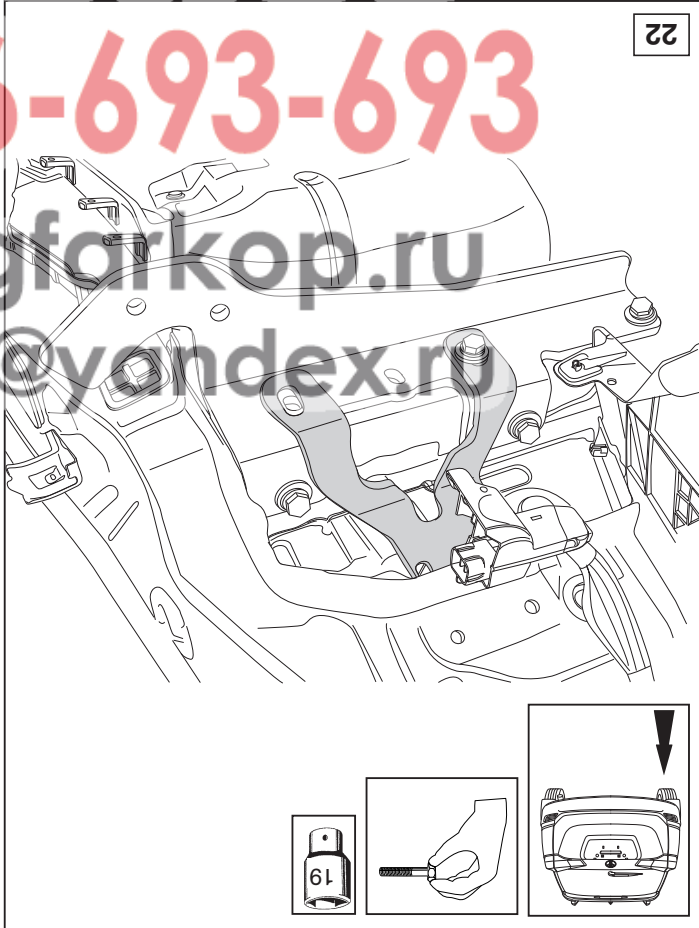
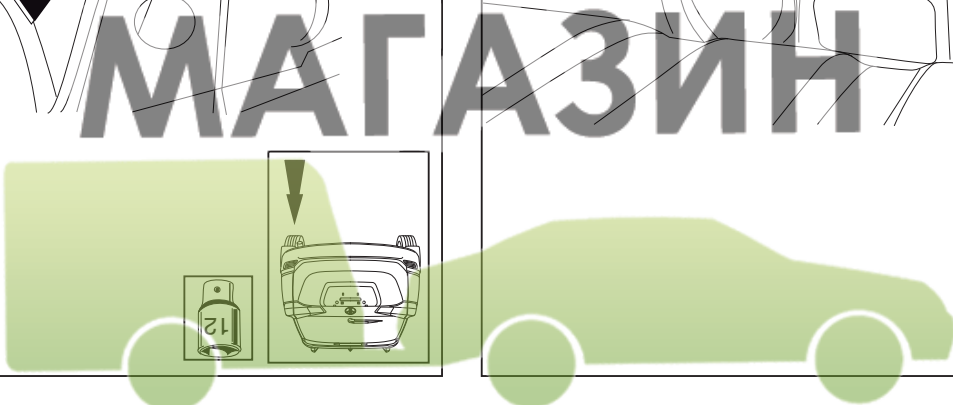
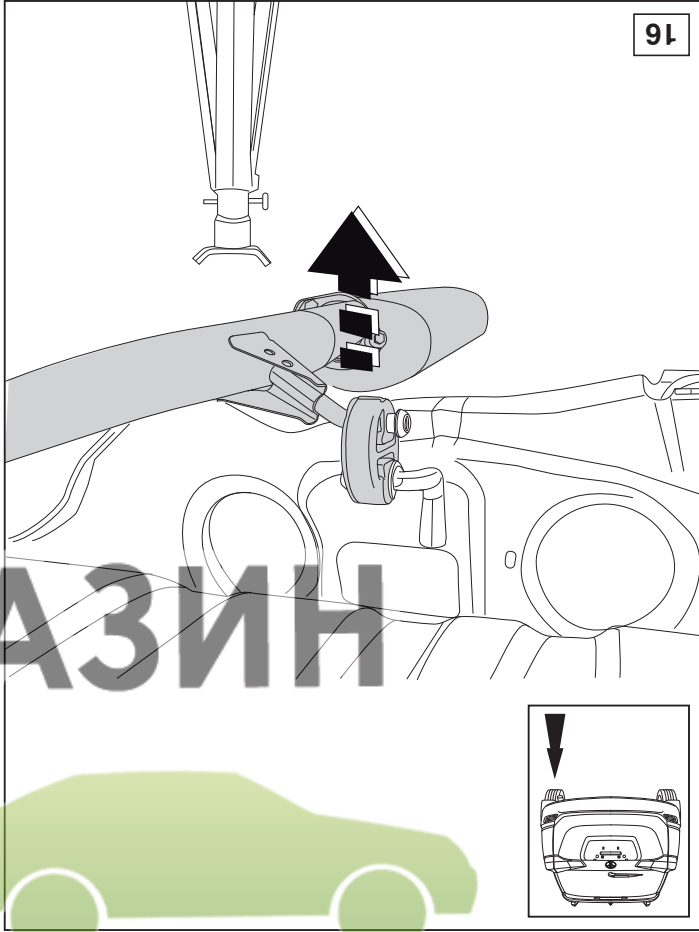
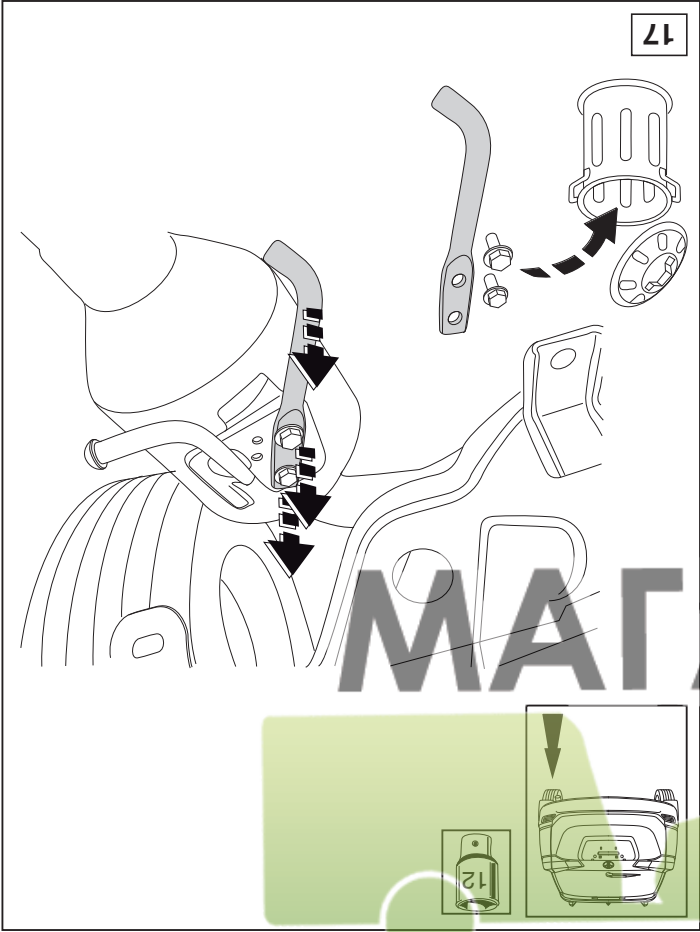

+7 (495) 9-993-993

www.magfarkop.ru
magfarkop@yandex.ru

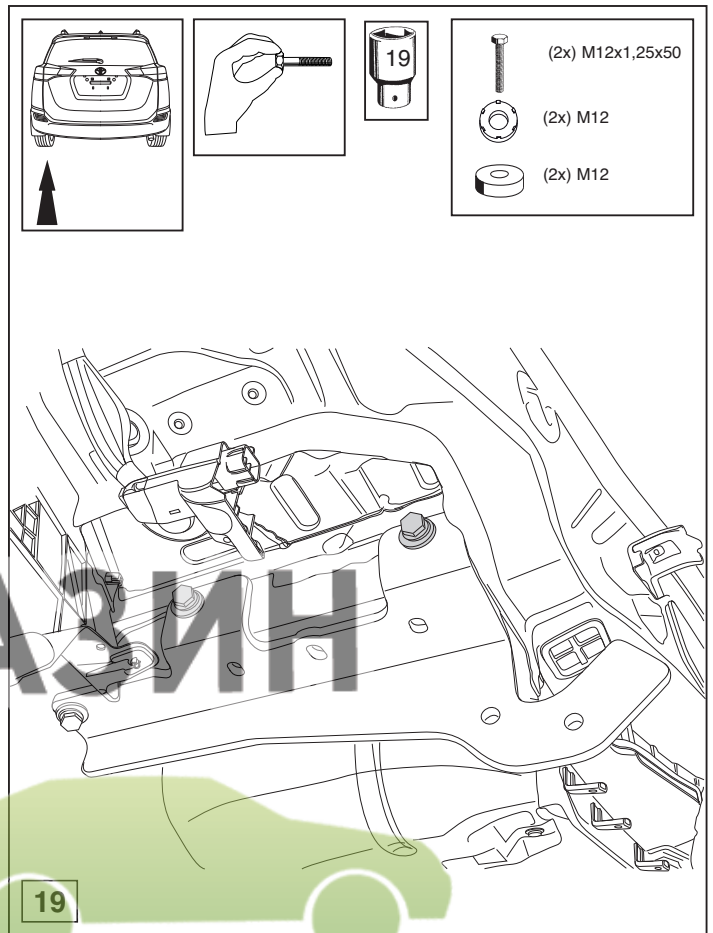
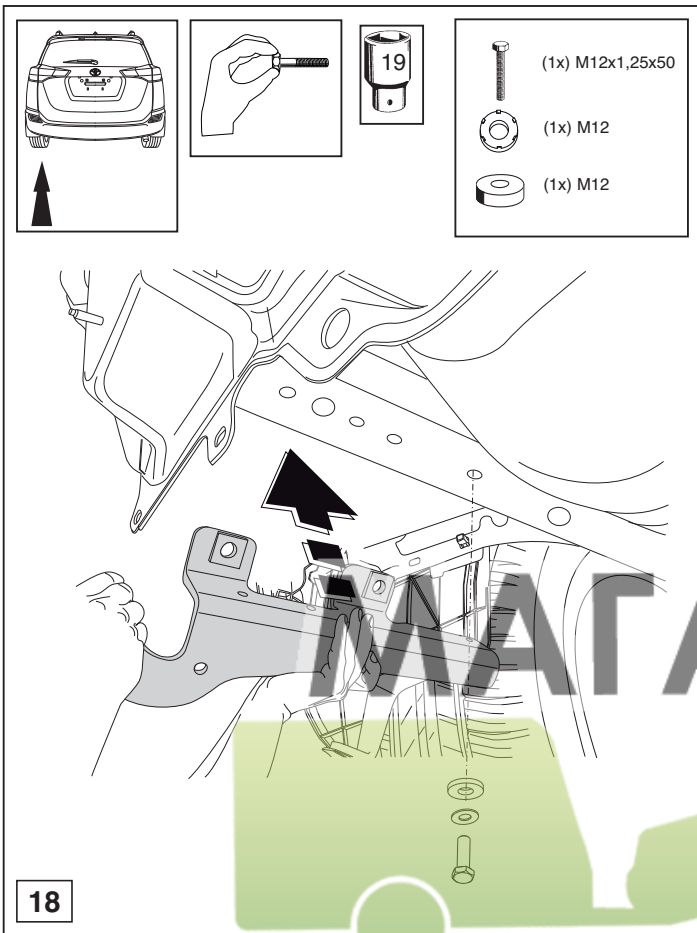

© 570370/27-05-2013/15

МАГАЗИН ФАРКОПОВ

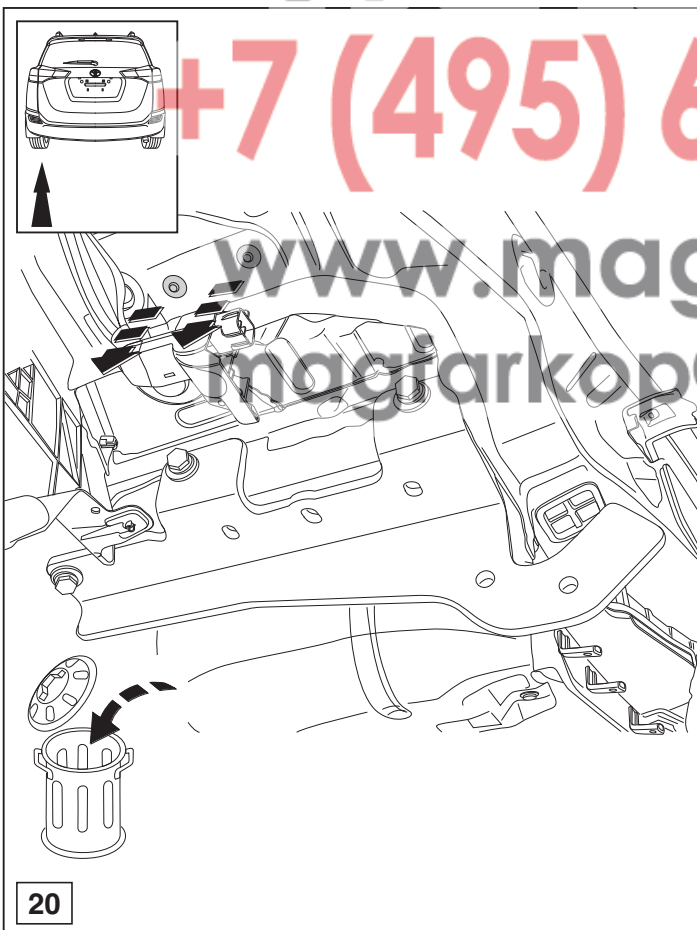

© 570370/27-05-2013/16

+7 (495) 6-693-693
www.magfarkop.ru
magfarkop@yandex.ru